

PrevaLED SKY G2 Module

路灯用LED模块

产品特点

- (可提供) 色温 : 3000 K、4000 K 或 6500 K



产品系列数据表

技术参数

产品描述	电参数		光度数据		尺寸和重量	温度
	标称电流	电流类型	发光效率	显色指数 Ra	产品重量	工作温度范围
PL-SKY-G2 730L100X100 W/P	0.7 安培	DC	129 lm/W	70	350.00 g	-30...90 °C
PL-SKY-G2 730L100X60 W/P	0.7 安培	DC	129 lm/W	70	350.00 g	-30...90 °C
PL-SKY-G2 730L60X60 W/P	0.7 安培	DC	129 lm/W	70	350.00 g	-30...90 °C
PL-SKY-G2 730L150X80T40C W/P	0.7 安培	DC	129 lm/W	70	350.00 g	-30...90 °C
PL-SKY-G2 730L150X80T40S W/P	0.7 安培	DC	129 lm/W	70	350.00 g	-30...90 °C
PL-SKY-G2 740L100X100 W/P	0.7 安培	DC	135 lm/W	70	350.00 g	-30...90 °C
PL-SKY-G2 740L100X60 W/P	0.7 安培	DC	135 lm/W	70	350.00 g	-30...90 °C
PL-SKY-G2 740L60X60 W/P	0.7 安培	DC	135 lm/W	70	350.00 g	-30...90 °C
PL-SKY-G2 740L150X80T40C W/P	0.7 安培	DC	135 lm/W	70	350.00 g	-30...90 °C
PL-SKY-G2 740L150X80T40S W/P	0.7 安培	DC	135 lm/W	70	350.00 g	-30...90 °C
PL-SKY-G2 765L100X100 W/P	0.7 安培	DC	132 lm/W	70	350.00 g	-30...90 °C
PL-SKY-G2 765 L 100x60 W/P	0.7 安培	DC	132 lm/W	70	350.00 g	-30...90 °C
PL-SKY-G2 765L60X60 W/P	0.7 安培	DC	132 lm/W	70	350.00 g	-30...90 °C
PL-SKY-G2 765L150X80T40C W/P	0.7 安培	DC	132 lm/W	70	350.00 g	-30...90 °C
PL-SKY-G2 765L150X80T40S W/P	0.7 安培	DC	132 lm/W	70	350.00 g	-30...90 °C
PL-SKY-G2 840L100X100 W/P	0.7 安培	DC	132 lm/W	80	350.00 g	-30...90 °C

产品描述	仓储温度范围	认证与标准		物流数据
		防护类型	标准	商品编码
PL-SKY-G2 730L100X100 W/P	-30...85 °C	IP66	根据 IEC 62471标准/根据 IEC 60598-1标准/根据 EN 60529标准/根据 EN 62031标准/根据 IEC 60598-1 (Class I)标准/根据 EN 55015标准/根据 EN 61547标准	854370909900
PL-SKY-G2 730L100X60 W/P	-30...85 °C	IP66	根据 IEC 62471标准/根据 IEC 60598-1标准/根据 EN 60529标准/根据 EN 62031标准/根据 IEC 60598-1 (Class I)标准/根据 EN 55015标准/根据 EN 61547标准	854370909900
PL-SKY-G2 730L60X60 W/P	-30...85 °C	IP66	根据 IEC 62471标准/根据 IEC 60598-1标准/根据 EN 60529标准/根据 EN 62031标准/根据 IEC 60598-1 (Class I)标准/根据 EN 55015标准/根据 EN 61547标准	854370909900
PL-SKY-G2 730L150X80T40C W/P	-30...85 °C	IP66	根据 IEC 62471标准/根据 IEC 60598-1标准/根据 EN 60529标准/根据 EN 62031标准/根据 IEC 60598-1 (Class I)标准/根据 EN 55015标准/根据 EN 61547标准	854370909900

产品系列数据表

产品描述	仓储温度范围	认证与标准		物流数据
		防护类型	标准	商品编码
PL-SKY-G2 730L150X80T40S W/P	-30...85 °C	IP66	根据 IEC 62471标准/根据 IEC 60598-1标准/根据 EN 60529标准/根据 EN 62031标准/根据 IEC 60598-1 (Class I)标准/根据 EN 55015标准/根据 EN 61547标准	888888888888
PL-SKY-G2 740L100X100 W/P	-30...85 °C	IP66	根据 IEC 62471标准/根据 IEC 60598-1标准/根据 EN 60529标准/根据 EN 62031标准/根据 IEC 60598-1 (Class I)标准/根据 EN 55015标准/根据 EN 61547标准	854370909900
PL-SKY-G2 740L100X60 W/P	-30...85 °C	IP66	根据 IEC 62471标准/根据 IEC 60598-1标准/根据 EN 60529标准/根据 EN 62031标准/根据 IEC 60598-1 (Class I)标准/根据 EN 55015标准/根据 EN 61547标准	854370909900
PL-SKY-G2 740L60X60 W/P	-30...85 °C	IP66	根据 IEC 62471标准/根据 IEC 60598-1标准/根据 EN 60529标准/根据 EN 62031标准/根据 IEC 60598-1 (Class I)标准/根据 EN 55015标准/根据 EN 61547标准	854370909900
PL-SKY-G2 740L150X80T40C W/P	-30...85 °C	IP66	根据 IEC 62471标准/根据 IEC 60598-1标准/根据 EN 60529标准/根据 EN 62031标准/根据 IEC 60598-1 (Class I)标准/根据 EN 55015标准/根据 EN 61547标准	854370909900
PL-SKY-G2 740L150X80T40S W/P	-30...85 °C	IP66	根据 IEC 62471标准/根据 IEC 60598-1标准/根据 EN 60529标准/根据 EN 62031标准/根据 IEC 60598-1 (Class I)标准/根据 EN 55015标准/根据 EN 61547标准	854370909900
PL-SKY-G2 765L100X100 W/P	-30...85 °C	IP66	根据 IEC 62471标准/根据 IEC 60598-1标准/根据 EN 60529标准/根据 EN 62031标准/根据 IEC 60598-1 (Class I)标准/根据 EN 55015标准/根据 EN 61547标准	854370909900

产品系列数据表

产品描述	仓储温度范围	认证与标准		物流数据
		防护类型	标准	商品编码
PL-SKY-G2 765 L 100x60 W/P	-30...85 °C	IP66	根据 IEC 62471标准/根据 IEC 60598-1标准/根据 EN 60529标准/根据 EN 62031标准/根据 IEC 60598-1 (Class I)标准/根据 EN 55015标准/根据 EN 61547标准	854370909900
PL-SKY-G2 765L60X60 W/P	-30...85 °C	IP66	根据 IEC 62471标准/根据 IEC 60598-1标准/根据 EN 60529标准/根据 EN 62031标准/根据 IEC 60598-1 (Class I)标准/根据 EN 55015标准/根据 EN 61547标准	854370909900
PL-SKY-G2 765L150X80T40C W/P	-30...85 °C	IP66	根据 IEC 62471标准/根据 IEC 60598-1标准/根据 EN 60529标准/根据 EN 62031标准/根据 IEC 60598-1 (Class I)标准/根据 EN 55015标准/根据 EN 61547标准	854370909900
PL-SKY-G2 765L150X80T40S W/P	-30...85 °C	IP66	根据 IEC 62471标准/根据 IEC 60598-1标准/根据 EN 60529标准/根据 EN 62031标准/根据 IEC 60598-1 (Class I)标准/根据 EN 55015标准/根据 EN 61547标准	854370909900
PL-SKY-G2 840L100X100 W/P	-30...85 °C	IP66	根据 IEC 62471标准/根据 IEC 60598-1标准/根据 EN 60529标准/根据 EN 62031标准/根据 IEC 60598-1 (Class I)标准/根据 EN 55015标准/根据 EN 61547标准	854370909900

Environmental information

Information according Art. 33 of EU Regulation (EC) 1907/2006 (REACH)

产品描述	Date of Declaration	Primary Article Identifier	Candidate List Substance 1	Declaration No. in SCIP database
PL-SKY-G2 730L100X100 W/P	19-01-2022	4052899573710	No declarable substances contained	No declarable substances contained
PL-SKY-G2 730L100X60 W/P	19-01-2022	4052899573734	No declarable substances contained	No declarable substances contained
PL-SKY-G2 730L60X60 W/P	19-01-2022	4052899573758	No declarable substances contained	No declarable substances contained
PL-SKY-G2 730L150X80T40C W/P	19-01-2022	4052899573772	No declarable substances contained	No declarable substances contained
PL-SKY-G2 730L150X80T40S W/P	19-01-2022	4052899573796	No declarable substances contained	No declarable substances contained
PL-SKY-G2 740L100X100 W/P	19-01-2022	4052899573819	No declarable substances contained	No declarable substances contained

产品系列数据表

产品描述	Environmental information			
	Information according Art. 33 of EU Regulation (EC) 1907/2006 (REACH)			
	Date of Declaration	Primary Article Identifier	Candidate List Substance 1	Declaration No. in SCIP database
PL-SKY-G2 740L100X60 W/P	19-01-2022	4052899573833	No declarable substances contained	No declarable substances contained
PL-SKY-G2 740L60X60 W/P	19-01-2022	4052899573857	No declarable substances contained	No declarable substances contained
PL-SKY-G2 740L150X80T40C W/P	19-01-2022	4052899573871	No declarable substances contained	No declarable substances contained
PL-SKY-G2 740L150X80T40S W/P	19-01-2022	4052899573895	No declarable substances contained	No declarable substances contained
PL-SKY-G2 765L100X100 W/P	19-01-2022	4052899573918	No declarable substances contained	No declarable substances contained
PL-SKY-G2 765 L 100x60 W/P	19-01-2022	4052899573932	No declarable substances contained	No declarable substances contained
PL-SKY-G2 765L60X60 W/P	19-01-2022	4052899573956	No declarable substances contained	No declarable substances contained
PL-SKY-G2 765L150X80T40C W/P	19-01-2022	4052899573970	No declarable substances contained	No declarable substances contained
PL-SKY-G2 765L150X80T40S W/P	19-01-2022	4052899573994	No declarable substances contained	No declarable substances contained
PL-SKY-G2 840L100X100 W/P	19-01-2022	4052899574014	No declarable substances contained	No declarable substances contained

产品系列数据表

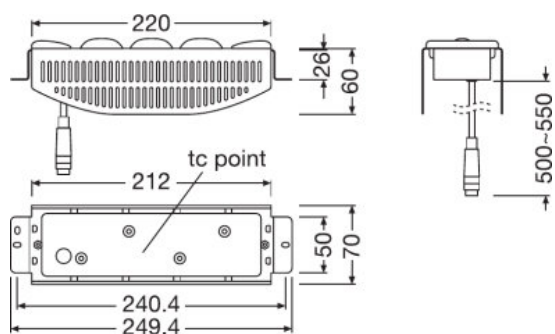

Line Drawing of PrevaLED SKY G2 Module

应用建议

更多详细应用信息和图形,请参阅产品数据表。







销售和技术支持

销售和技术支持 www.osram.cn

下载数据

文件	
	IES data IES file for PL-SKY-G2 730L100X100
	IES data IES file for PL-SKY-G2 730L100X60
	IES data IES file for PL-SKY-G2 730L100X100
	IES data IES file for PL-SKY-G2 730L150X80T40C
	IES data IES file for PL-SKY-G2 730L150X80T40S
	IES data IES file for PL-SKY-G2 740L100X100
	IES data IES file for PL-SKY-G2 740L100X60
	IES data IES file for PL-SKY-G2 740L60X60
	IES data IES file for PL-SKY-G2 740L150X80T40C

产品系列数据表

	IES data IES file for PL-SKY-G2 740L150X80T40S
	IES data IES file for PL-SKY-G2 765L100X100
	IES data IES file for PL-SKY-G2 765L100X60
	IES data IES file for PL-SKY-G2 765L60X60
	IES data IES file for PL-SKY-G2 765L150X80T40C
	IES data IES file for PL-SKY-G2 765L150X80T40S

物流数据

产品代码	产品描述	包装单位 (件/单位)	尺寸 (长 x 宽 x 高)	体积	毛重
4052899573710	PL-SKY-G2 730L100X100 W/P	箱 12	312 mm x 290 mm x 272 mm	24.61 dm ³	4902.00 g
4052899573734	PL-SKY-G2 730L100X60 W/P	箱 12	312 mm x 290 mm x 272 mm	24.61 dm ³	4902.00 g
4052899573758	PL-SKY-G2 730L60X60 W/P	箱 12	312 mm x 290 mm x 272 mm	24.61 dm ³	4902.00 g
4052899573772	PL-SKY-G2 730L150X80T40C W/P	箱 12	312 mm x 290 mm x 272 mm	24.61 dm ³	4902.00 g
4052899573796	PL-SKY-G2 730L150X80T40S W/P	箱 12	312 mm x 290 mm x 272 mm	24.61 dm ³	4902.00 g
4052899573819	PL-SKY-G2 740L100X100 W/P	箱 12	312 mm x 290 mm x 272 mm	24.61 dm ³	4902.00 g
4052899573833	PL-SKY-G2 740L100X60 W/P	箱 12	312 mm x 290 mm x 272 mm	24.61 dm ³	4902.00 g
4052899573857	PL-SKY-G2 740L60X60 W/P	箱 12	312 mm x 290 mm x 272 mm	24.61 dm ³	4902.00 g
4052899573871	PL-SKY-G2 740L150X80T40C W/P	箱 12	312 mm x 290 mm x 272 mm	24.61 dm ³	4902.00 g
4052899573895	PL-SKY-G2 740L150X80T40S W/P	箱 12	312 mm x 290 mm x 272 mm	24.61 dm ³	4902.00 g
4052899573918	PL-SKY-G2 765L100X100 W/P	箱 12	312 mm x 290 mm x 272 mm	24.61 dm ³	4902.00 g
4052899573932	PL-SKY-G2 765 L 100x60 W/P	箱 12	312 mm x 290 mm x 272 mm	24.61 dm ³	4902.00 g
4052899573956	PL-SKY-G2 765L60X60 W/P	箱 12	312 mm x 290 mm x 272 mm	24.61 dm ³	4902.00 g
4052899573970	PL-SKY-G2 765L150X80T40C W/P	箱 12	312 mm x 290 mm x 272 mm	24.61 dm ³	4902.00 g

产品系列数据表

物流数据

4052899573994	PL-SKY-G2 765L150X80T40S W/P	箱 12	312 mm x 290 mm x 272 mm	24.61 dm ³	4902.00 g
4052899574014	PL-SKY-G2 840L100X100 W/P	箱 12	312 mm x 290 mm x 272 mm	24.61 dm ³	4902.00 g

这里所提到的产品编码代表最小订购数量。一个整件包装含有一个或多个单一产品。请您在下单时，按一个或多个整件数下单。

免责声明

更改恕不另行通知。遗漏错误不承担任何责任。总是确保使用最新的信息。